

# SPEEDCHECK®

## Variable Speed Limit Sign



Variable speed limit signs display scheduled and spontaneous adjustments to posted speed limits using high-visibility illuminated digits, increasing compliance and safety in school zones, work zones, highways, and more.

- ✓ Industry-leading high-contrast display technology for visibility in all weather and lighting conditions
- ✓ Local and remote programming options
- ✓ Most recognized radar speed sign in the industry for 20+ years
- ✓ Built-in radar collects speed data and vehicle counts
- ✓ MUTCD and Buy America compliant

### Superior Design and Technology

The SpeedCheck variable speed limit sign can be used to alert drivers to modified speed limits necessitated by changing weather and traffic conditions using a highly visible black-and-white LED display.

Available in 15-inch and 18-inch digit sizes, the display uses a 7-segment design with high-contrast technology for visibility in all weather and lighting conditions. SpeedCheck's proprietary safety mask limits the viewing angle to prevent drivers from watching the display as they pass.

### Easy Installation and Durable Construction

The display's modular design makes the model easy to install and maintain using standard tools.

Designed to withstand the elements, the display is constructed with heavy 11-gauge welded aluminum and stainless steel and brass hardware. The vandal-resistant design has been proven to absorb up to two inches of impact deflection without damage to internal components.

### Local and Remote Programming and Control

Speed limit changes can be programmed on a schedule or updated on the fly using our SpeedCheck Manager software with either a remote Ethernet or local Bluetooth connection.

### Trusted for 20+ Years

With thousands of installations, Carmanah's systems are the benchmark in traffic applications and other transportation applications worldwide.

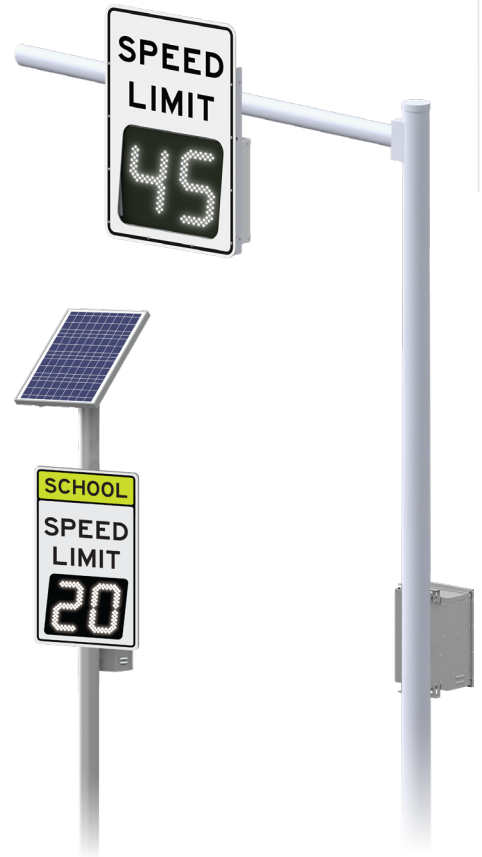

### SPEEDCHECK-15-VS

15-inch-digit model with optional S5-1 school zone speed limit sign

### SPEEDCHECK-18-VS

18-inch-digit model with standard R2-1 speed limit sign for speeds over 45 mph (70 km/h)

# SPEEDCHECK®

## Variable Speed Limit Sign

1.844.412.8395 | traffic@carmanah.com | carmanah.com



### DISPLAY ENCLOSURE DIMENSIONS

#### SPEEDCHECK-15-VS

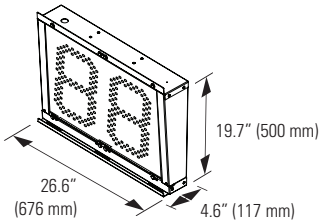

#### SPEEDCHECK-18-VS

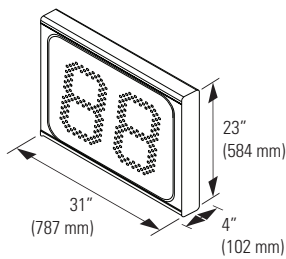

### DISPLAY ENCLOSURE MOUNTING

#### Standard Banding

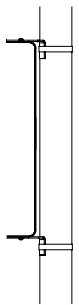

#### U-Bolt (Flat/Square poles)

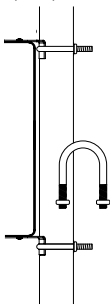

#### Tilt Bracket (for vertical adjustments)

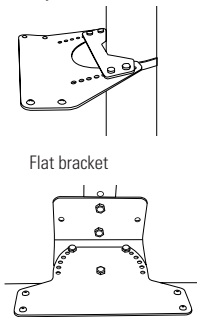

#### Quick Change (Portable)

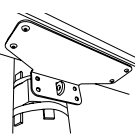

#### Flat bracket

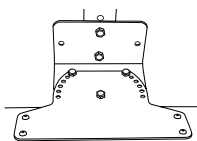

### SOLAR PANEL MOUNTING

#### 4.5" Diameter Round Top of Pole Mount

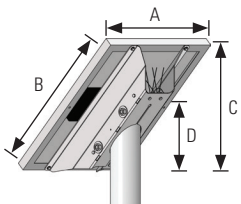

#### Side of Pole Mount

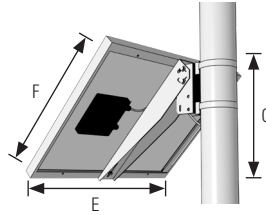

PANELS*	A	B	C	D	E	F	G
50 W	21.2" (538 mm)	26.3" (668 mm)	19.6" (497 mm)	10.0" (254 mm)	26.3" (668 mm)	21.2" (538 mm)	16.0" (405 mm)
80 W	30.7" (780 mm)	26.5" (672 mm)	19.7" (500 mm)	10.0" (254 mm)	30.7" (780 mm)	26.5" (672 mm)	19.7" (500 mm)
170 W	59.1" (1500 mm)	26.3" (668 mm)	19.7" (501 mm)	10.0" (254 mm)	59.1" (1500 mm)	26.3" (668 mm)	35.7" (907 mm)

\* Carmanah will conduct a site assessment and provide an Energy Balance Report™ to determine the correct solar panel and battery size.

### CABINET DIMENSIONS

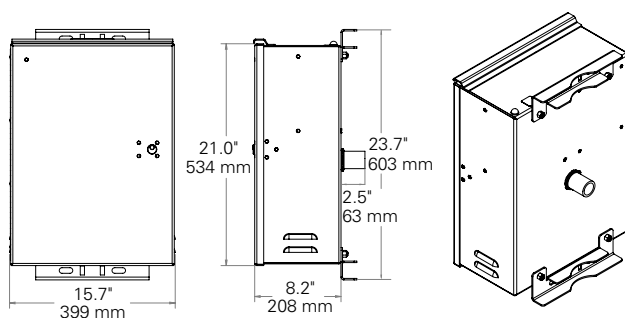

### SYSTEM SPECIFICATIONS

Display	MUTCD and MUTCDC compliant White LEDs Seven-segment LED digit design for maximum digit recognition LEDs automatically dim during nighttime operation, minimizing light bounce into neighboring windows
Power	Unique safety masking design limits display view from the side, discouraging drivers from rubbernecking to watch the display as they drive past Ultra-clear contrast delivers superior viewability in all lighting conditions No "88" digit ghosting even in bright sunlight 100-240 VAC in standard configurations 12 VDC for battery or solar system operation Solar sized for specific geographic location and sign application 3.5 W draw for typical daytime displayed number, traffic, and local illumination 50, 80, or 170 W high-efficiency photovoltaic solar panel
Enclosure	Ventilated, weatherproof NEMA 3R enclosure
Static Sign Construction	3M High Intensity Prismatic or Diamond Grade retroreflective sheeting and components Available in 3931 yellow, 3983 fluorescent yellow/green, 3930 white, and 3934 orange; others available
Communication	Local Bluetooth or remote Ethernet connection
Software	SpeedCheck Manager: simple setup and programming for all display parameters
Cabinet Construction	Weatherproof, gasketed enclosure with vents for ambient air transfer (NEMA 3R) Lockable, hinged door with #2 lock Optional padlockable latch Corrosion-resistant aluminum with stainless steel hardware
Environmental	-40 to 167° F (-40 to 75° C) system operating temperature 5-30 Hz 3-axis vibration FCC 15.107 and 15.109 Class A radiated and conducted emissions compliance FCC part 15 low-power radar device
Warranty	<b>3-year limited warranty</b>

### OPTIONAL PRODUCT FEATURES

Outputs	Triggers external devices, such as flashing beacons or cameras by speed threshold or schedule, or from centralized remote location Beacons: 12 in (305 mm) or 8 in (203 mm) diameter LED modules, yellow
Inputs	Allows external devices to manage display operation with external contact closure and the included wiring harness

### "SPEED LIMIT" SIGN DIMENSIONS

#### R2-1 Speed Limit Sign

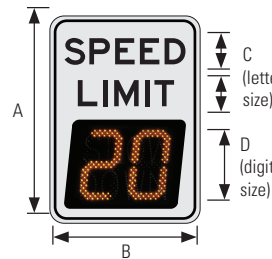

#### S5-1 School Zone Speed Limit Sign (15-inch model only)

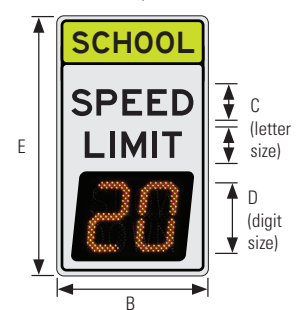

SIGN	A	B	C	D	E
15-inch	42" (1067 mm)	30" (762 mm)	6" (152 mm)	15" (381 mm)	52" (1321 mm)
18-inch	48" (1219 mm)	36" (914 mm)	6.5" (165 mm)	18" (457 mm)	-



Specifications subject to local environmental conditions, and may be subject to change.

All Carmanah products are manufactured in facilities that are certified to ISO quality standards.

"Carmanah" and Carmanah logo are trademarks of Carmanah Technologies Corp.

© 2020, Carmanah Technologies Corp.

Document: SPEC\_TRA\_SpeedCheck-variable-speed-signs\_RevA